

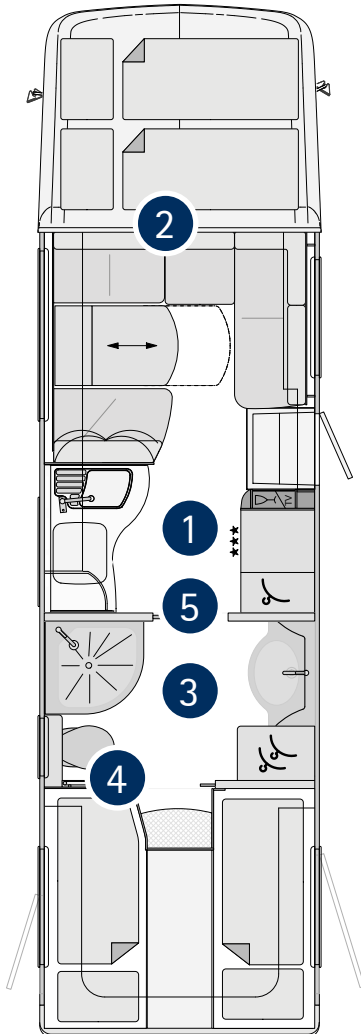

Technical Information 2016

Concorde
REISEMOBILE AUS LEIDENSCHAFT

The standard „highlights“ of the Cruiser:



1

Room zone heating

The multifunctional adjustable warm water heating system creates four different warm areas which can be tempered separately from each other: living room, wellness area and bedroom are tempered through thermostatic valve, the temperature of the garage is regulated through a Three-Way-Cock. Through two temperature sensors in the living room and bedroom, one of the temperature sensors can be determined as preference room. Through this the advance temperature of the heating is regulated. Heat by every trick in the book.



2

Heated separating plate for driver's cab

Two additional heating areas separate the unheated driver's cab. In the neck area are located warm air streams which keep the head and neck area warm and increase the well-being. In the pass the cold inlet air is heated under the sliding door and keeps in that manner the area of the feet warm.



3

Two-zone-underfloor heating

Two separately adjustable underfloor heating's enable to heat up the living room floor and the bathroom floor separately depending on the individual needs. The close meshed network of the heating pipe heats up the floor equally and increases the well-being.



4

Towel radiator in bathroom

The towel radiator provides a cuddly warmth in the bathroom and a preheated towel. In combination with the underfloor heating, the bathroom is going to be a comfortable, feel good place.



5

Helping frame

The helping frame has the task to connect the body with the chassis and represents the fundament of your motorhome. Such as the foundation wall of a house has the task to fix the house on the lot. In combination with the double floor construction there is generated a possibly wrap resistant body.

The standard „highlights“ of the Cruiser:



6

Carrying construction

Two Alu frame in the double floor provide a stable "cellar construction" by connecting the helping frame with the living room floor and a solid box is created. Furniture and wall construction should be connected permanently with each other.



7

Electric packet

The serial power packet consists of a combination charger with inverter from 12 V to 230 V Sinus, 3000 W max and 1600 W continuous output with electronic regulation and network strength code as well as a maximal charge current 60 A. Two gel batteries with in total 340 Ah guarantee as standard a high battery capacity. Thus providing its own 230 V supply as standard.



8

Entrance door "Security Plus"

The entrance door "Security Plus" offers a particular break-in safety due to the key-less implementation. The stable alu interior frame and the three covered installed hinges allow additional safety. The comfortable opening and closing is effected through a key field. In case of power breakdown the access to the motor-home is granted through an emergency switch.



9

Coming Home

Illumination of the entry steps inside and outside – for a safe step and an illuminated return.



10

Automated speed transmission system

The power source is an automated 6-speed transmission system. From 1230 L upwards the 8 gear Powershift-3 transmission is standard. In combination with the perfectly balanced and tuned drive shaft, the Atego offers an efficient spontaneous and economic gear. The Atego offers outstanding efficiency and exceptional driving pleasure. The breaking power of the Atego is supplemented by a two stage engine brake with a maximum output of up to 273 kW.

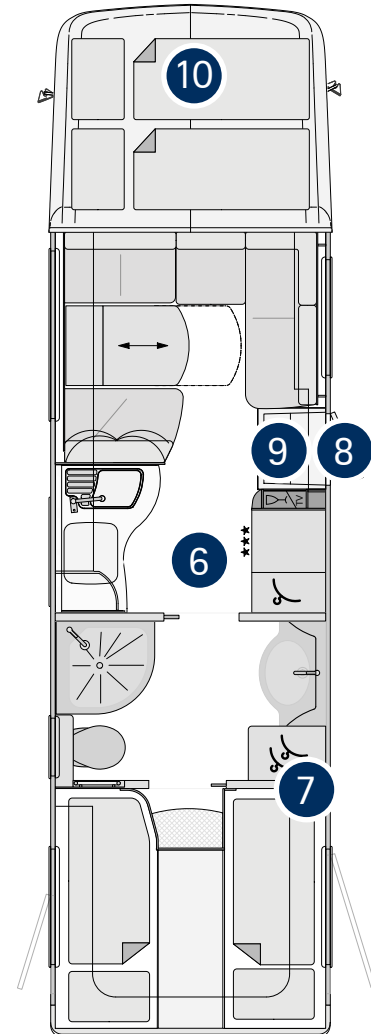

Standard equipment

CHASSIS

MB
Atego

Turbo-diesel engine with rear-wheel drive and twin tyres	•
Tyres for up to 10 tonne chassis	235 / 75R17,5
Tyres for 12 tonne chassis	285 / 70R19,5
Rear axle tyres with traction profile (M+S)	•
Disc brakes on the front and rear axle	•
Dual-circuit compressed air brake	•
Electronically regulated anti-lock braking system (ABS)	•
Engine brake	•
Brake system with EVB engine brake system (increased braking efficiency)	•
Cruise Control	•
Upgraded 3 phase alternator 28 V / 150 A incl. 2 x 45 A charging converter (for charging the leisure battery)	•
Fuel tank capacity	180 l
Driver's cab air conditioning	•
Rear body wall with integrated LED taillights	•
Exterior side mirrors with wide angle mirror, electronically heated and adjustable	•
Front bumper in driver's cab colour	•
Central locking system driver's cab with remote control	•
Steering wheel with adjustable height and tilt	•
Hazard warning triangle, first-aid kit, warning lights and wheel chock	•
Automated 6-speed transmission (for chassis variant 923 L and 924 L, 8-speed transmission for chassis variant 1230 L)	•
Stability assist	•
Air suspension on the front axle (from chassis variant 1230 L)	•
Air suspension on the rear axle with the function „lifting and lowering“	•

Standard equipment

BODY

CRUISER

Smoky tinted double-glazed windows in living room, lift or slide opening (depends on mounting position), with pleated shade blind and fly screen	•
Highly stable, durable aluminium composite construction Solidtherm	•
Thermal-bridge-free, fully insulated wall-joint technology using high-density solid PU profiles	•
40 mm wall thickness, of which 38 mm closed-cell RTM hard foam	•
Walls, roof and under floor internally and externally in high-quality aluminium sandwich construction	•
Side walls in sheet smooth, white stove-enamelled	•
Fully accessible roof on either side of the roof lights	•
Aluminium roof moulding	•
Side skirting panels constructed from highly stable corrosion resistant fiberglass composite material	•
Rear wall made of fiberglass composite sandwich with PU foam core	•
Heated double floor with approx. 420 mm height, accessible through external side flaps	•
Heavy duty rollers on rear chassis	•
Storage space flaps with cast aluminium hinges and low-maintenance, high-quality needle felt on the inside, frame with thermal break	•
Sandwich under and in-between floor with 40 mm or 30 mm thick RTM foam, total floor insulation 70 mm	•
Rear axle wheel arches in fully insulated sandwich construction	•
Illuminated rear garage with garage doors left and right and lashing system	•
Illuminated internal entry step with heating	•
External electric retractable entrance step with safety circuit breaker and lighting	•
„Security Plus“ entrance door with number combination security lock and emergency key switch, „Interstop“ door security	•
Fly screen for entrance door	•
Outdoor lamp with security switch (automatic switch-off when engine starts)	•
Comfort seats in Original textile, with air suspension, lumbar support, shoulder adjustment and heating	•
Rear garage floor with aluminium checker plate	•

Standard equipment

LIVING ROOM / BEDROOM AREA

CRUISER

Furniture flaps and doors:

- European Wenge (veneered on both sides)

High-quality microfibre for walls and ceiling

Floor covering. Colour: Parquet flooring optic

Living room suite ergonomically formed, high-quality textile / microfibre upholstery with zips (body)

High-quality sliding curtains

Spacious wardrobe with LED lighting

Rear bed with bed base, adjustable headrest and comfortable cold foam mattress

Sliding door to the cab / living room side, lockable

Double-glazed panorama skylight (Heki 3) with lighting in living room, fly screen and pleated shade blind

Mini-Heki with fly screen and pleated shade blind in bedroom area

TV sideboard in entrance area

Entrance cabinet incl. a collection of glasses and LED lighting

Light canopies with LED spotlights and indirect lighting with a high-quality artificial leather cover

Robust metal entrance handle for boarding assistance

1 x 12 V socket (living room) and 3 x 230 V sockets (1 x living room, 2 x bedroom area)

-
-
-
-
-
-
-
-
-
-
-
-
-
-

Standard equipment

ALCOVEN BED

CRUISER

Bed size (in mm)	2100 x 1550
Height above bed (in mm)	700
Comfortable cold foam mattress with bed base	•
Tinted double-glazed windows, lift opening, with pleated shade blind and fly screen	•
Mini-Heki with fly screen and pleated shade blind	•
Storage console with LED spotlights in alcoven bed on driver's side	•
Driver's cab curtains	•
Access ladder and safety net for fall out protection with bayonet fasteners	•

KITCHEN

Kitchen area with splashguard	•
Mineral kitchen worktop with seamless moulded integrated sink. Colour: marble white	•
Stainless steel three flame hob with automatic ignition and glass cover	•
High-quality design chrome single lever mixer tap with pull-out sprinkler head	•
190-l-refrigerator with separate 31-l-freezer compartment, refrigerator with dark reflective front.	•
AES (automatic and manual energy selection 12 V / 230 V / gas), 28-l-gas oven with grill function	•
Drawers with Servo-Soft closing	•
Integrated cutlery drawer	•
Roof ventilator	•
Lighting with LED spotlights in light canopy and under the wall cupboards	•
Integrated waste bin system in lower kitchen cupboard	•
2 x 230 V sockets	•
Exclusive kitchen corner cabinet, lowered	•

Standard equipment

BATHROOM / TOILET

CRUISER

High-quality design chrome single lever mixer tap on washstand in household quality	•
Mineral bathroom worktop with a seamless moulded integrated washbasin. Colour: marble white	•
Separate shower with real glass doors incl. removable clothes rail	•
Shower fittings with wall mounting and height adjustable shower head	•
Porcelain toilet with approx. 230-l-fixed tank	•
Bathroom fittings with toilet paper holder, toilet brush, liquid soap dispenser, hand towel hooks and rail, toothbrush glass	•
Toilet window	•
Mini-Heki with fly screen and pleated shade blind	•
Lighting with LED spotlights	•
Wardrobe with lighting	•
Full-length mirror on sliding door	•
Spacious mirror cabinet with backlit shelves	•
1 x 230 V sockets	•

WATER / GAS / HEATING

Gas bottle compartment for 2 x 11 kg gas bottles	•
Gas controller „Duocontrol“ with crash sensor and automatic bottle changing	•
Sink siphon	•
Fresh water tank approx. 320 l located in heated double floor	•
Waste water tank approx. 230 l located in heated double floor	•
Convenient waste water tank emptying with drain cock in heated double floor	•
External cleaning opening on all tanks, accessible from living room	•
Waste water drain hose with quick release fixing and cover cap	•

Standard equipment

WATER / GAS / HEATING

CRUISER

Automatically functioning central water pressure pump with filter system	•
Alde hot water-gas-central heating 5500 W with thermostat and timer, electrical heating cartridge 230 V / 3000 W, backflow lock with integrated hot water boiler to maintain all tapping points	•
Heating system bedroom area / garage, thermostatic adjustable	•
2-zone underfloor heating, separately adjustable	•
2-zone living room heating, separately adjustable (1 x living area + bathroom, 1 x bedroom area)	•
Towel radiator in bathroom with room thermostat	•
Engine heat exchanger which uses the motor's cooling water to heat the living room	•
Heated separation wall to cab	•

ELECTRICAL / TV / RADIO

Gel battery 2 x 170 Ah	•
Battery monitoring system with deep discharge protection	•
230 V CEE connection in storage space with cable routing through vehicle floor	•
RCD automatic personal protection	•
Combination charging unit with inverter from 12 V to 230 V, Sinus 3000 W max and 1600 W continuous output, with electric control and mains priority circuit, maximum charging current 60 A	•
Disconnection of on-board electrics when capacity limit is reached with automatic restarting function	•
1 x 230 V socket at the control centre positioned in in-between floor	•
Radio in driver's cab with CD, MP3 and USB port, 2-way speaker system	•
LED lighting in interior	•
Service friendly access to on-board electronics with perforated plate housing in rear garage (in external storage compartment on the right for G-models)	•
Automatic chargeover of refrigerator when engine is switch off, from 12 V to gas / 230 V (land connection)	•
Automatic charging of the leisure and vehicle battery, charge is maintained by vehicle alternator as well as whilst driving	•
Circuit breaker for leisure battery	•
Automatic disconnection and connection of leisure and vehicle battery	•

Standard equipment

ON-BOARD ELECTRONICS

CRUISER

Highly modern microprocessor-controlled electrical system with BUS (Binary Unit System)

•

Centralized control panel with 7" touch-screen colour display

•

Select buttons for switching on and off the following devices:

• Panel

•

• Lighting

•

• Water pump

•

• Heating

•

LCD display for monitoring:

• Fresh water tank (fill level in %)

•

• Waste water tank (fill level in %)

•

• Septic tank (fill level in %)

•

• Battery voltage of the vehicle and leisure battery

•

• Outdoor and indoor temperature

•

• External power supply

•

• Gas level (only in conjunction with gas tank)

•

• Battery parallel circuit

•

• Date and time with alarm function

•

Alarm systems for:

• Waste water tank full

•

• Fresh water tank empty

•

• Septic tank full

•

• Battery undervoltage

•

• Reserve gas bottle in use

•

• Extended entrance step

•

Battery computer:

• Leisure battery capacity indicator

•

• Charging and discharging current

•

Technical specifications

CRUISER 890 L / 890 LR

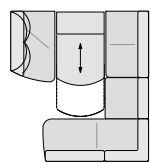

standard seating group

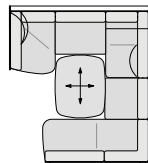

Lounge suite

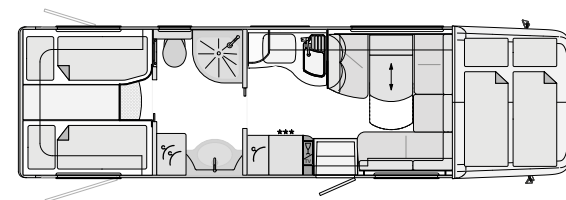

Basic vehicle	MB Atego
Chassis type	923 L
Engine	4-cylinder
Engine capacity	5,1 l
Output	170 kW (231 hp)
Torque	900 Nm
Overall length (mm)	8930
Overall width (mm)	2480
Overall height (mm)	3750
Wheelbase (mm)	4520
Gross vehicle weight ratio (kg)	9500
Mass in running order (kg)	7610
Payload (kg)	1890
Towing capacity braked (kg)	3500
Seats with three point seatbelts	4
Bench seat left (mm)	2000
Bench seat right (mm)	1500
Rear bed (mm)	2 x 2000 / 845
Alcoven bed dimensions (mm)	2100 / 1550
Height above Alcoven bed (mm)	700
Garage door right, H / W (mm)	1250 / 1150
Garage door left, H / W (mm)	1250 / 800

For further information concerning measurements and weight specifications see page 18.

Technical specifications

CRUISER 940 M / 940 MR

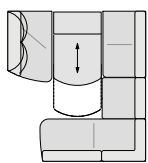

standard seating group

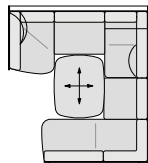

Lounge suite

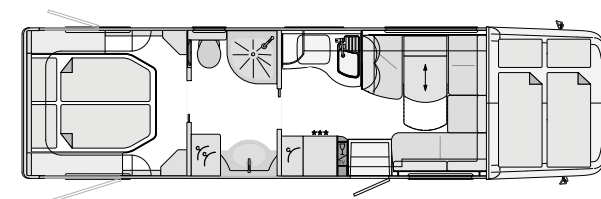

Basic vehicle	MB Atego
Chassis type	1230 L
Engine	6-cylinder
Engine capacity	7,7 l
Output	220 kW (299 hp)
Torque	1200 Nm
Overall length (mm)	9430
Overall width (mm)	2480
Overall height (mm)	3860
Wheelbase (mm)	4760
Gross vehicle weight ratio (kg)	11990
Mass in running order (kg)	8720
Payload (kg)	3270
Towing capacity braked (kg)	3000
Seats with three point seatbelts	4
Bench seat left (mm)	2000
Bench seat right (mm)	1500
Rear bed (mm)	2000 / 1570
Alcoven bed dimensions (mm)	2100 / 1550
Height above Alcoven bed (mm)	700
Garage door right, H / W (mm)	1250 / 1150
Garage door left, H / W (mm)	1250 / 800

For further information concerning measurements and weight specifications see page 18.

CRUISER 990 G / 990 GR

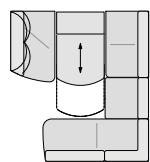

standard seating group

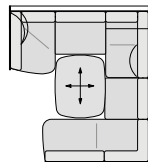

Lounge suite

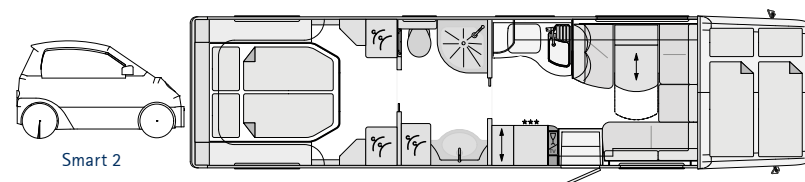

Smart 2

Basic vehicle	MB Atego
Chassis type	1230 L
Engine	6-cylinder
Engine capacity	7,7 l
Output	220 kW (299 hp)
Torque	1200 Nm
Overall length (mm)	10090
Overall width (mm)	2480
Overall height (mm)	3860
Wheelbase (mm)	5360
Gross vehicle weight ratio (kg)	11990
Mass in running order (kg)	9040
Payload (kg)	2950
Towing capacity braked (kg)	3000
Seats with three point seatbelts	4
Bench seat left (mm)	2000
Bench seat right (mm)	1500
Rear bed (mm)	2000 / 1570
Alcoven bed dimensions (mm)	2100 / 1550
Height above Alcoven bed (mm)	700
Garage flap H / W	1510 / 1760

For further information concerning measurements and weight specifications see page 18.

Chassis optional equipment

Artikel-no.	CHASSIS MERCEDES BENZ ATEGO	ADDITIONAL WEIGHT in kg
700511-16	Tow bar with towable mass 3500 kg (3000 kg from MB Atego 1230 L) (only available factory-fitted)	29
7000416-16	Electrical prearrangement tow bar	5
125118-16	Comfort driver's cab seats	60
146018-16	Differential lock for rear axle	15
703501-16	Dashboard in aluminium trim (chrome interior decor in driver's cab)	2
703502-16	Dashboard in wood trim (matt wood interior decor in driver's cab)	2
7005012-16	6.75 x 17.5" „Alcoa Dura bright" alloy wheel rims with standard tyres (spare wheel steel rim) (MB Atego 923 L)	-56
7005017-16	7.50 x 19.5" „Alcoa Dura bright" alloy wheel rims with standard tyres (spare wheel steel rim) (MB Atego 1230 L)	-60
700097-16	Hydraulic supporting jacks with automatic levelling	139
700098-16	Hydraulic supporting jacks with automatic levelling (G-models)	139
702244-16	Stainless steel hubcaps 17,5" (MB Atego 923 L)	8
702246-16	Stainless steel hubcaps 19,5" (MB Atego 1230 L)	8
703405-16	Original steering wheel in leather with real chrome trim	3
703425-16	Original steering wheel in leather with real wood trim	3
709179-16	Engine variant 924 (6 cylinder, 7.7 l, 175 kW (238 hp), 1000 Nm) available for: 890 L / LR	4
125025-16	Automated 8-speed transmission system (only in conjunction with no. 709179-16)	51
145051-16	High Performance engine brake	6
709181-16	Chassis variant 12000 kg 1230 L instead of 923 L (6 cylinder, 7.7 l, 220 kW (290 hp), 1200 Nm, towable mass 3000 kg, height 3860 mm, wheelbase 4460 mm) Chassis with 19,5" tyres Air suspension on the front axle Automated 8-speed transmission available for: 890 L / LR	980
1050801-16	Dual pressure air horn	3
125013-16	Commitment charge incl. full series fuel tank and Adblue tank	0

Body optional equipment

Artikel-no.	BODY	ADDITIONAL WEIGHT in kg
700305-16	1 x lap belt in bench seat facing backwards (5-person approval, only for Lounge suite)	5
700306-16	2 x lap belt in bench seat facing backwards (6-person approval, only for standard seating group)	30
700143-16	Roof awning 6 m, electric	66
7012031-16	LED side wall lighting underneath the awning	2
7062290-16	Central locking system for storage space flaps (without the skirting panel flaps, the gas locker door and the garage door of G-models)	5
701610-16	Living room windows with shading in privacy black	0

LIVING ROOM / BEDROOM AREA

125246-16	Ambience Packet Noce Furniture in Noce with roof cabinet fronts in „high gloss“ Senosan cream white Living room windows with shading in privacy black Venetian blinds with wood slats living room Soft-walk floor covering: Yacht flooring optic Linked and removable living room carpet Concorde Collection (2 x small pillows, 1 x big pillow, 2 x blankets)	29
701554-16	Height adjustable living room table with upholstered chairs (only Lounge suite)	8
700754-16	Midi-Heki instead of Mini-Heki (living room)	6
7007542-16	Panorama skylight (Heki 3) instead of Mini-Heki (bedroom area)	19
700812-16	Roof cabinet fronts in „high gloss“ Senosan cream white	8
7001045-16	Venetian blinds with wood slats living room	5
7006674-16	Higher entrance cabinet incl. a collection of glasses and LED lighting (not in conjunction with TV in entrance area)	10

Artikel-no. **KITCHEN**

700436-16	Stainless steel microwave with grill function under hob, 230 V operation via land connection, 26-l-oven (not in conjunction with dishwasher)	22
701899-16	Dishwasher under hob (not in conjunction with microwave)	25

Body optional equipment

Artikel-no.	ELECTRICAL	ADDITIONAL WEIGHT in kg
700743-16	Electric power packet 1 x gel battery 170 Ah additional (total of 3 batteries), combination charger 100 A with network strength code, Sinus inverter from 12 V to 230 V, 4000 W max and 2200 W continuous output with network compensator	60
701200-16	Alarm system with surveillance of the interior, the garage flaps and the living room door	3
700853-16	Built-in 2600 W gas generator (only in conjunction with gas tank)	50
7006845-16	Double reverse camera with shutter (picture through separate screen)	4
700720-16	Solar panels with approx. 120 W maximal power	15
700722-16	Solar panels with approx. 2 x 120 W maximal power	30

TV / RADIO / TELEPHONE

	Satellite TV set with 85 cm dish, fully automatic tuning, multiple user facilities through TWIN-LNB, port for second receiver with 12 V / 230 V and antenna socket in bedroom area, sound reproduction over radio	
700560-16	Satellite TV set 1 with 24" LED flat screen in entrance area	38
7005671-16	Satellite TV set 2 with 24" LED flat screen in right overhead cupboard, electrically height adjustable	45
7005601-16	Satellite TV set with 32" LED flat screen in right overhead cupboard, electrically height adjustable	50
700576-16	Internet satellite TV set with 24" LED flat screen in entrance area, set with TV reception function, GPS SKEW and Internet access	38
700515-16	W-LAN router, Fritz-Box, Wi-Fi (only in conjunction with no. 700576-16)	1
700604-16	Navigation system (with truck software and 6.2" touch-screen, integrated radio with DVD, CD and MP3 playback, hands-free device for telephone with Bluetooth)	4
7005682-16	22" LED flat screen for rear bedroom area with integrated TV receiver	15
700594-16	Radio in body with CD, DVD and MP3 playback, sound system with subwoofer and additional speaker	15
7005102-16	Combination 230 V / 12 V / antenna / socket with cable routing in the floor. Position: in the external storage space on the right side of the vehicle (for optional external TV connection) (satellite output)	1
700675-16	DVB-T external antenna for reception of terrestrial TV (for two TV sets)	2
706346-16	DAB+ Digital radio, premium quality sound system with additional added features	3

Body optional equipment

Artikel-no.	WATER / GAS / HEATING / BATHROOM	ADDITIONAL WEIGHT in kg
700412-16	External shower in the garage (driver's side)	2
700863-16	„Motor Caravan“ diesel block heater with convenient permanent heating function (5200 W) incl. time switch	10
701881-16	Waste water tank approx. 320 l instead of 230 l	8
700898-16	Gas alarm for monitoring living room (carbon monoxide, propane, butane, narcotic gas)	2
7008901-16	Gas tank approx. 120 l with remote gas switch, gas prefilter, secondary gas filling point, crash sensor and contents indicator through the control panel display, incl. skirting panel flap (incl. full tank of gas)	104
700401-16	External gas socket on the passenger's side (BBQ point)	1
700830-16	Roof air conditioning 2400 W with heating element 1700 W	34
700832-16	Air conditioning 2400 W for living room with infrared remote control (mounting in double floor)	37
701813-16	SOG-Comfort toilet ventilation with activated carbon filter for fixed tank (extracted direct from toilet bowl)	1
700580-16	Smart-Control for Alde hot water heating	1
7015305-16	Mirrored cabinet in- and outside	1

Body optional equipment

Artikel-no.	UPHOLSTERY / LEATHER / CARPET	ADDITIONAL WEIGHT in kg
809250-16	Textile / microfibre upholstery „Cream“, ribbed optic	0
809251-16	Textile / microfibre upholstery „Caramel“, ribbed optic	0
809240-16	Faux leather upholstery „Toffee“ with „Redonda“ foam-optic	15
809234-16	Leather upholstery „Mother of pearl“, ribbed optic	25
809235-16	Leather upholstery „Savanna“, ribbed optic	25
809236-16	Leather upholstery „Stone“, ribbed optic	25
809213-16	Exclusive leather upholstery „Rustic Grey“, ribbed optic (natural material with visual inclusions and different surface optics possible)	25
308020-16	Driver's cab seats covered in living room textile / microfibre instead of the chassis manufacturer's original upholstery	0
308010-16	Driver's cab seats covered in living room leather instead of the chassis manufacturer's original upholstery	5
308030-16	Driver's cab seats covered in exclusive leather upholstery „Rustic Grey“ instead of the chassis manufacturer's original upholstery	5
870100-16	Upholstery textile / microfibre with „Redonda“ foam-optic	0
870000-16	Upholstery leather with „Redonda“ foam-optic	0
860000-16	Concorde Collection: 2 x small pillows, 1 x big pillow, 2 x blankets	8
7001121-16	Soft-walk floor covering: Yacht flooring optic	0
700824-16	Soft-walk floor covering: Slate flooring optic	0
7001553C-16	Linked and removable living room carpet. Colour: cream	10
7001553G-16	Linked and removable living room carpet. Colour: grey brown	10

Concorde exclusively uses high-quality fabric and leather with a special stain resistance coating.

Sectional drawing

CONCORDE CRUISER CABIN CONSTRUCTION

In motorhome construction, Concorde stands for perfect insulation and outstanding stability. This is primarily down to the lack of thermal loss, completely sealed Solidtherm cabin construction with polyurethane rigid foam ledges as well as the insulation of the side walls with 38 millimetre strong RTM foam. And as if that was not enough: Also the under and in-between floors are finished in a sandwich type construction and filled with a total of 70 millimetres of insulation. The exterior side skirt panels, bumpers as well as front and rear masks are formed from highly stable and nonetheless elastic fibreglass composite materials. The high gloss and flush wall surfaces are made from aluminium sandwich construction. Aluminium roof profile ledges with rainwater drainage channels to reduce sidewall staining. We give a 10-year water ingress warranty on the body against ingress of moisture from the outside in combination with annual inspection plan in accordance with the Concorde warranty conditions.

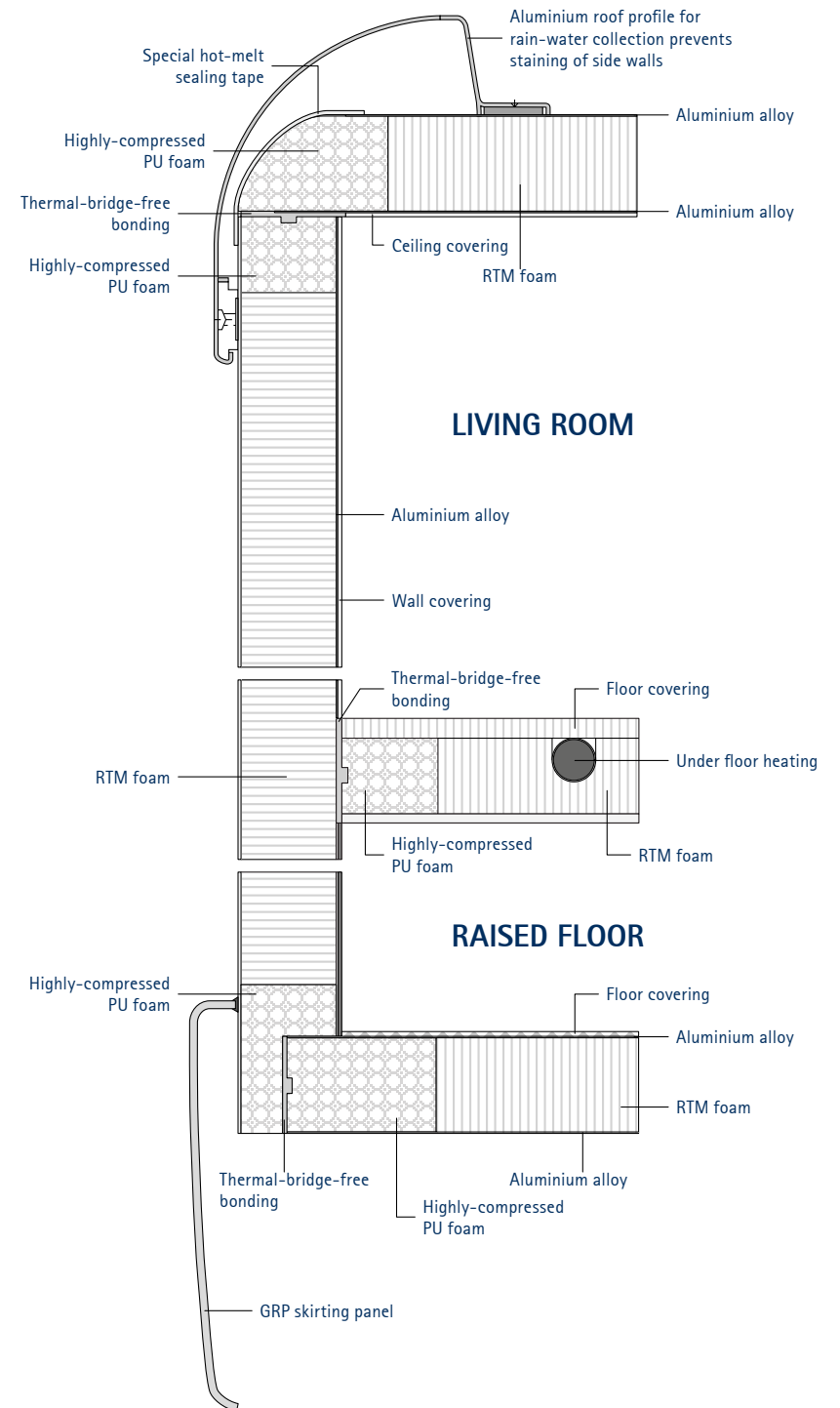

Technical modifications reserved provided that the overall product quality remains the same or is improved and the intended purpose is not impaired.
On publication of this technical information, all previous are rendered invalid. Subject to change without notice, errors excepted.

Concorde
REISEMOBILE AUS LEIDENSCHAFT

Concorde Reisemobile GmbH
Concorde-Straße 2-4, 96132 Schlüsselfeld-Aschbach
Telefon +49 (0) 95 55 / 92 25-0, Telefax +49 (0) 95 55 / 92 25-44
Internet: www.concorde.eu, E-Mail: info@concorde.eu